

MEKI

PROFESSIONAL IN SCREEN

PRODUCT CATALOG

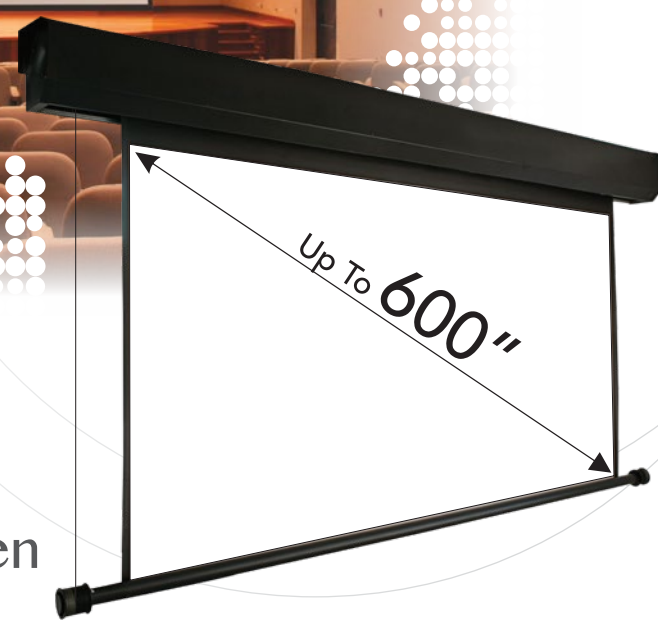

Vista Series Titan Engineering Screen

Meki Titan Engineering Screen is the best solution for theaters and other large-scale demonstrations sites. It is designed for both indoor or outdoor stages. Meki TES uses Pro-Matte white screen fabric, and the maximum width is up to 12 metres. It is equipped with a heavy duty bottom bar which stabilizes and keeps the screen to remain flat at all times, without deformation. Comes with built-in high quality silent tubular motor and built-in receiver.



Control System



Wall switch Remote
RC01



Wall switch Remote
RC02

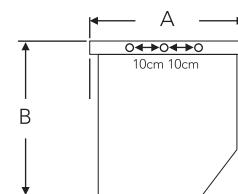
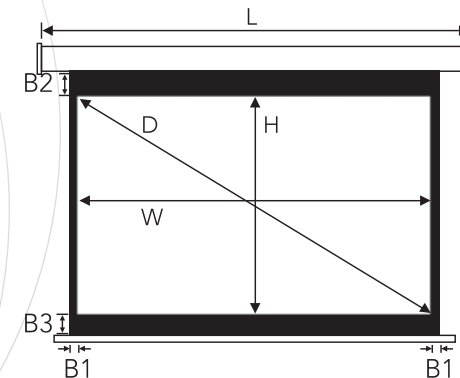

Installation diagram

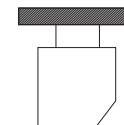

Model	Ratio	Diagonal (inch)	Viewing Size W x H (mm)			Left & Right Black Border (mm)	Top Black Border (mm)	Bottom Black Border (mm)	Casing Size L x A x B (mm)		
			D	W	H				B1	B2	B3
TES-NTSC-250D	4:3	250	4980	3740	50	50	50	5610	400	420	
TES-NTSC-300D		300	6000	4500	50	50	50	6630	400	420	
TES-NTSC-400D		400	8010	6010	60	60	60	8660	450	500	
TES-NTSC-500D		500	10020	7520	70	70	70	10690	450	500	
TES-NTSC-600D		600	12040	9030	80	80	80	12730	450	500	
TES-NTSC-250D	16:9	250	5400	3050	50	50	50	6070	400	420	
TES-NTSC-300D		300	6530	3670	60	60	60	7180	400	420	
TES-NTSC-400D		400	8920	4900	70	70	70	9390	450	500	
TES-NTSC-400D		500	10920	6130	80	80	80	11610	450	500	

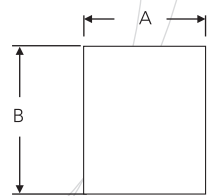
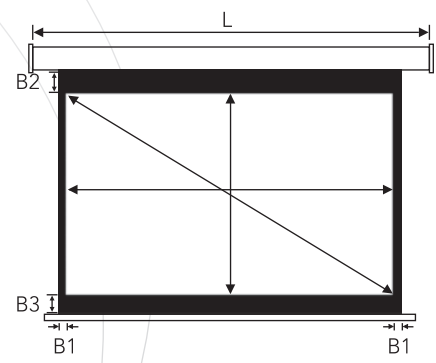

Installation Diagram

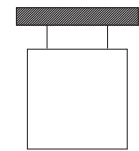

Step 1:



Step 2:



Step 3:

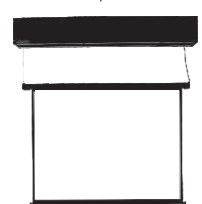

Vista Series Twice Lifting Screen

Meki Twice Lifting Screen is suitable for wide space and tall ceiling environment like hotels banquet halls, exhibition halls, auditoriums and large meeting rooms. The main feature of Meki TLS is the motorised wired screen which drops the screen from a high roof or ceiling. It solves the difficulty of installation process on high position. TLS drops and unfolds the screen within 5 meters height. It has a built-in, safe and reliable anti-falling system. Equipped with high-grade, dual-band wireless remote control which is able to control both motors from long range.

Model	Ratio	Diagonal (inch)	Viewing Size W x H (mm)			Left & Right Black Border (mm)	Top Black Border (mm)	Bottom Black Border (mm)	Casing Size L x A x B (mm)		
			D	W	H				B1	B2	B3
TL100VM	4:3	100	1910	1430	25	25	25	2490	400	420	
TL120VM		120	2300	1730	25	25	25	2880			
TL150VM		150	2890	2170	50	50	50	3520			
TL200VM		200	3960	2970	50	50	50	4590			
TL92HM	16:9	92	1910	1070	25	25	25	2490	400	420	
TL106HM		106	2300	1290	25	25	25	2880			
TL138HM		138	2890	1620	25	25	25	3470			
TL200HM		200	4330	2430	50	50	50	4960			
TL250HM		250	5440	3050	50	50	50	6070			



Anti drop device



Control System



Wall switch RC01 Remote



Wall switch RC02 Remote



Vista Series In-Ceiling Screen

Integrating a ceiling recessed projection screen was never this easy. Meki In-Ceiling Screen is designed to be hidden in ceiling, the screen can be easily concealed and the installation is simple and quick. The solid shell board combines both practicality and beauty. Meki ICS has standard black edges surrounding the screen, which effectively absorbs the misaligned lights from the projector. It makes the edges of projected images sharp and clean. Furthermore Meki ICS are applicable to any types of ceilings.

Control System



Wall switch Remote
RC02

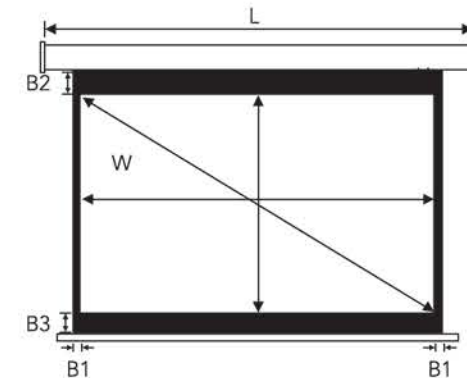

Installation Diagram

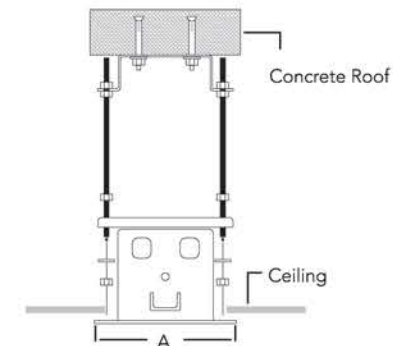

Model	Ratio	Diagonal (inch)			Viewing Size (mm)			Left & Right Black Border (mm)			Top Black Border (mm)			Bottom Black Border (mm)			Casing Size L x A x B (mm)		
		D	W	H	B1	B2	B3	L	A	B									
CBS-NTSC-84D	4:3	84	1660	1250	25	50	25	1920	150	90									
CBS-NTSC-100D		100	1980	1490	25	50	25	2240											
CBS-NTSC-120D		120	2390	1790	30	80	30	2650											
CBS-NTSC-150D		150	2950	2240	30	80	30	3260											
CBS-NTSC-200D		200	3960	3050	40	40	40	4350											
CBS-HD-80D	16:9	80	1720	970	25	80	25	1990	150	90									
CBS-HD-92D		92	1990	1110	25	80	25	2240											
CBS-HD-110D		110	2390	1330	30	80	30	2650											
CBS-HD-138D		138	2950	1675	30	100	30	3260											
CBS-HD-155D		155	3330	1890	30	100	30	3640											

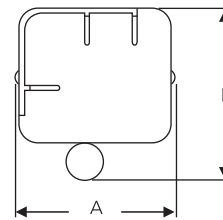
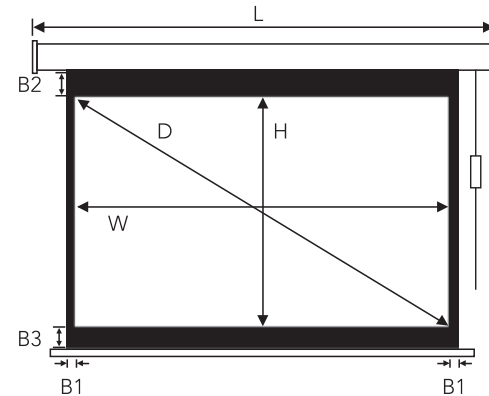

Installation Diagram:

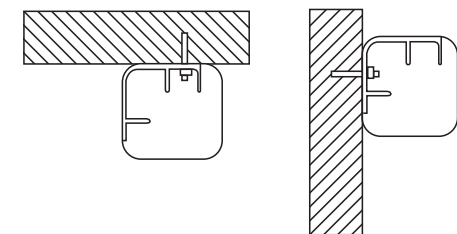

Vista Series Electric Screen

- Fully assembled for easy installation
- Motorized movement control
- Wired and wireless remote control
- Quite and fluid like movement with just a switch away
- Screen's fall height adjustable

Control System



Wall switch Remote RC01

Model	Ratio	Diagonal (inch)	Viewing Size W x H (mm)		Left & Right Black Border (mm)	Top Black Border (mm)	Bottom Black Border (mm)	Casing Size L x A x B (mm)		
		D	W	H	B1	B2	B3	L	A	B
MRS-AV-60	1:1	85	1470	1470	25	50	25	1730	89	89
MRS-AV-70		99	1730	1730	25	50	25	1990	89	89
MRS-AV-80		113	1980	1980	25	50	25	2240	89	89
MRS-AV-84		119	2080	2080	25	50	25	2340	89	89
MRS-AV-96		136	2390	2390	25	50	25	2650	89	89
MRS-AV-120		170	2990	2990	30	80	30	3260	89	89
MRS-AV-144		204	3600	3600	30	80	30	3870	89	89
MRS-NTSC-84D	4:3	84	1660	1250	25	50	25	1920	89	89
MRS-NTSC-100D		100	1980	1490	25	50	25	2240	89	89
MRS-NTSC-120D		120	2380	1790	30	80	30	2650	89	89
MRS-NTSC-150D		150	2990	2240	30	80	30	3260	98	98
MRS-NTSC-180D		180	3600	2580	40	40	40	3890	120	120
MRS-NTSC-200D		200	3980	2990	40	40	40	4270	160	160
MW-HD-92D	16:9	92	1980	1110	25	80	25	2240	89	89
MW-HD-100D		110	2380	1330	30	80	30	2650	89	89
MW-HD-120D		138	2990	1675	30	100	30	3260	89	89
MW-HD-150D		155	3370	1890	30	100	30	3640	98	98



Vista Series Electric Tab Tensioned Screen

- An upgrade version of electric screen
- With tubular motor and remote control
- Unique cable borders to ensure flat surface
- Both wall and ceiling mount available
- Wired and wireless remote access
- Perfect for board and conference room

Control System



Wall switch Remote
RC01



Wall switch Remote
RC02

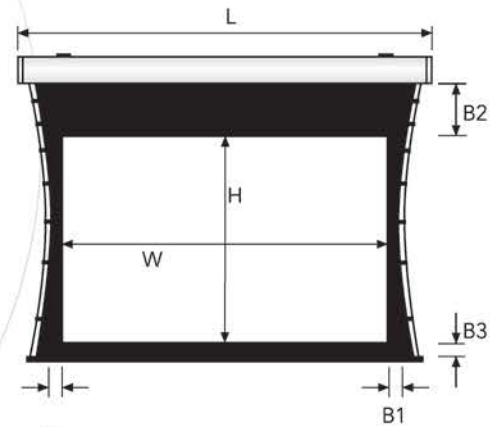

B1



Installation Diagram:

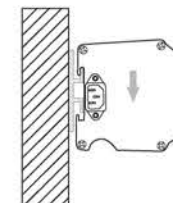
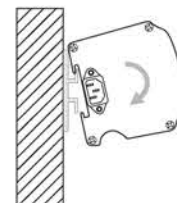
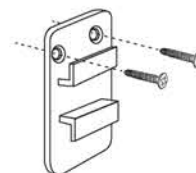

Casing Profile:

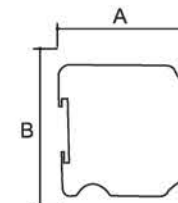

Model	Ratio	Diagonal (inch)	Viewing Size W x H (mm)		Left & Right Black Border (mm)	Top Black Border (mm)	Bottom Black Border (mm)	Casing Size L x A x B (mm)		
			D	W				H	L	A
TTM-NTSC-72D	4:3	72	1370	1110	50	200	30	1800	90	90
TTM-NTSC-84D		84	1650	1240				2080		
TTM-NTSC-100D		100	1970	1480				2400		
TTM-NTSC-120D		120	2380	1790				2810		
TTM-NTSC-150D		150	2990	2240				3420		

Home Theater
Projection Screen

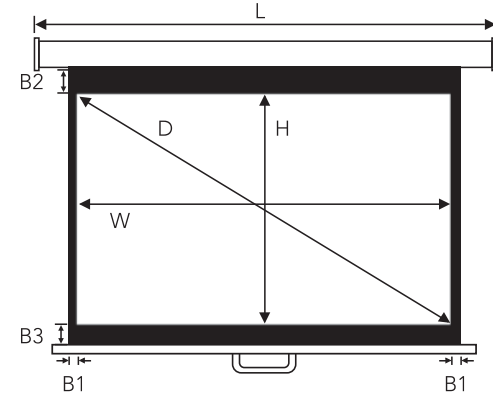
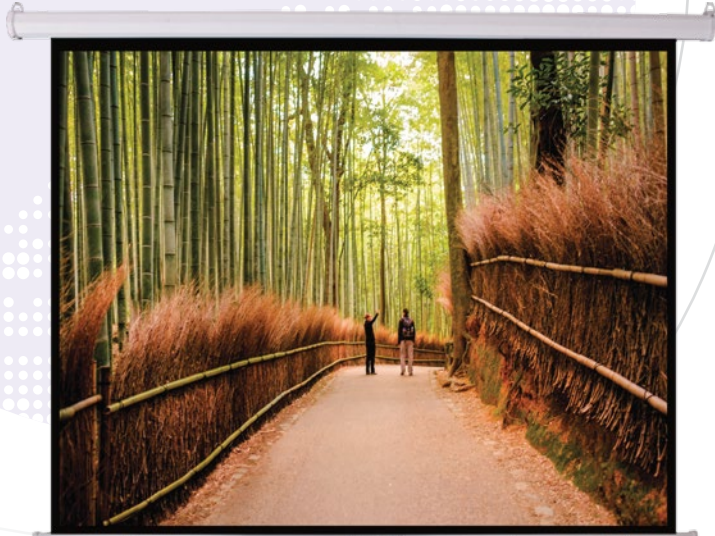

Casing Profile:

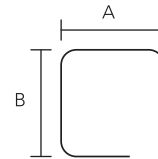

Installation Diagram:

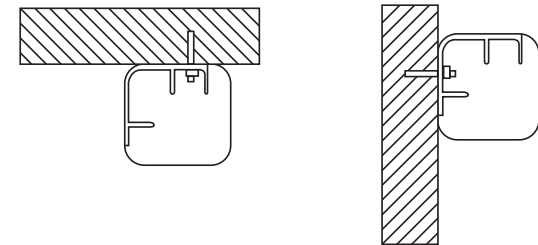

Vista Series Manual Screen

- Convenient hand pull adjuster
- Spring roller operated with auto stopping mechanism
- Easy to install
- Come with both wall and ceiling bracket
- Suitable for meeting rooms, schools and hotel function
- Durable in all environment condition



Model	Ratio	Diagonal (inch)	Viewing Size W x H (mm)		Left & Right Black Border (mm)	Top Black Border (mm)	Bottom Black Border (mm)	Casing Size L x A x B (mm)		
		D	W	H	B1	B2	B3	L	A	B
MW-AV-60	1:1	85	1470	1470	25	25	25	1600	64	64
MW-AV-70		99	1730	1730	25	25	25	1860	64	64
MW-AV-80		113	1980	1980	25	25	25	2110	64	64
MW-AV-84		119	2080	2080	25	25	25	2210	64	64
MW-NTSC-84D	4:3	84	1660	1250	25	25	25	1790	64	64
MW-NTSC-100D		100	1980	1490	25	25	25	2110	64	64
MW-NTSC-120D		120	2390	1790	25	25	25	2520	64	64
MW-NTSC-150D		150	2950	2240	50	50	50	3130	76	76
MW-HD-80D	16:9	80	1720	945	25	25	25	1850	64	64
MW-HD-92D		92	1990	1100	25	25	25	2120	64	64
MW-HD-110D		110	2390	1320	25	25	25	2520	64	64
MW-HD-138D		138	2950	1620	25	25	25	3080	64	64
MW-HD-155D		155	3330	1830	50	50	50	3510	76	76

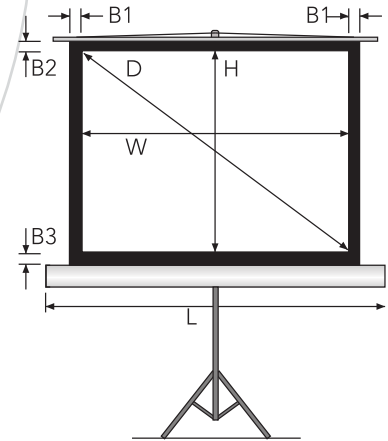

Casing Profile:

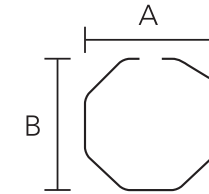

Vista Series Tripod Screen

- Lightweight and portable
- Easy assembly
- Adjustable height
- Rust proof metal coating
- Strong and sturdy built for all purpose use
- Suitable for school, office and even outdoor sales

Model	Ratio	Diagonal (inch)	Viewing Size W x H (mm)		Left & Right Black Border (mm)	Top Black Border (mm)	Bottom Black Border (mm)	Casing Size L x A x B (mm)		
		D	W	H	B1	B2	B3	L	A	B
TR-AV-60	1:1	85	1470	1470	25	25	25	1600		
TR-AV-70		99	1730	1730	25	25	25	1860		
TR-AV-80		113	1980	1980	25	25	25	2110	64	64
TR-AV-84		119	2080	2080	25	25	25	2210		
TR-AV-96		136	2380	2380	30	80	30	2520		
TR-NTSC-84D	4:3	84	1660	1250				1790		
TR-NTSC-100D		100	1980	1490	25	25	25	2110	64	64
TR-NTSC-120D		120	2390	1790				2520		
TR-HD-80D	16:9	80	1720	945				1850		
TR-HD-92D		92	1990	1100	25	25	25	2120	64	64
TR-HD-110D		110	2390	1320				2520		



Vista Series Ultra Slim Fixed Frame Screen

Experience the feeling of borderless design with the Meki SFF. It has a super narrow bezel which looks like a huge TV, the frame is made of aluminium alloy and just 1 centimetre width. It supports active3D and 4K ultra high resolution, improving the content visibility to the audience. The unobstructive display also features narrow bezels, which provides and broad viewing area on a near-seamless digital canvas.

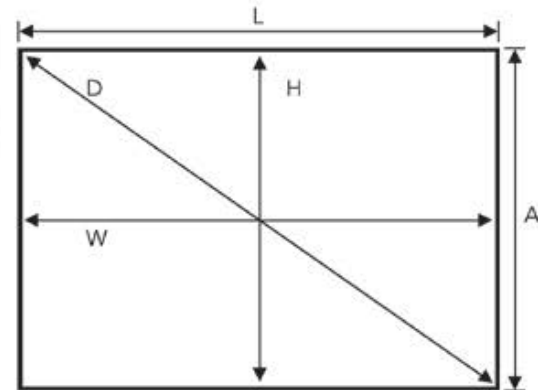

Installation Diagram:

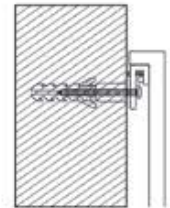
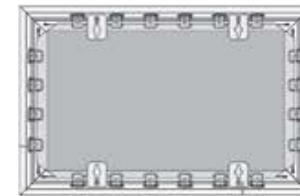

Model	Ratio	Diagonal (inch)	Viewing Size W x H (mm)		Frame Width (mm)	Product Size L x A x B (mm)		
		D	W	H	B	L	A	B
SFF84V	4:3	84	1710	1280	10	1730	1730	35
SFF100V		100	2030	1520		2050	1540	
SFF120V		120	2440	1830		2460	1850	
SFF150V		150	3050	2290		3070	2310	
SFF180V		180	3660	2740		3680	2760	
SFF200V		200	4060	3050		4080	3070	
SFF80H	16:9	80	1780	1000	10	1800	1020	35
SFF92H		92	2030	1140		2050	1160	
SFF110H		110	2440	1360		2460	1380	
SFF120H		120	2660	1490		2680	1510	
SFF133H		133	2940	1660		2960	1680	
SFF150H		150	3320	1870		3340	1890	
SFF180H		180	3950	2240		4000	2260	
SFF200H		200	4430	2490		4450	2510	



Vista Series Classic Fixed Frame

- Elegant and durable
- Simple installation system
- Perfect picture quality with flat surface
- In-house cinema experience
- Change of velvet color is available upon request
- Sleek frame design blends in well with modern interior concepts
- Special and custom sizes are available upon request and other fabric materials

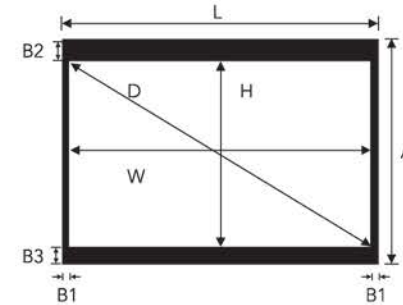

Installation Diagram:

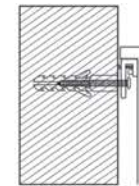
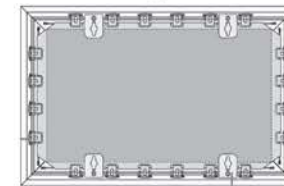

Model	Ratio	Diagonal (inch)	Viewing Size W x H (mm)		Frame Width (mm)	Casing Size L x A x B (mm)		
		D	W	H		L	A	B
FXB-3072	4:3	72	1460	1100	60	1790	1220	60
FXB-3084		84	1700	1280	60	2030	1400	60
FXB-3100		100	2030	1520	60	2360	2360	60
FXB-3120		120	2440	1830	80	2810	2810	80
FXB-3135		135	3050	2290	80	3420	3420	80
FXB-3150		150	3050	2290	80	3420	3420	80
FXB-3180		180	3660	2740	80	4030	4030	80
FXB-3200		200	3940	2930	80	4310	4310	80
FXB-9072	16:9	72	1590	900	60	1920	1920	60
FXB-9084		84	1870	1050	60	2200	2200	60
FXB-9092		92	2040	1150	60	2370	2370	60
FXB-9100		100	2210	1250	60	2540	2540	60
FXB-9106		106	2350	1320	60	2680	2680	60
FXB-9120		120	2660	1490	80	3030	3030	80
FXB-9135		135	2990	1680	80	3360	3360	80
FXB-9150		150	3320	1870	80	3690	3690	80
FXB-9159		159	3520	1980	80	3890	3890	80
FXB-9165		165	3650	2050	80	4020	4020	80
FXB-9180	180	3980	2240	80	4350	4350	80	
FXB-9200	200	4420	2500	80	4790	4790	80	
FXB-2085	2.35	85	1990	850	60	2320	2320	60
FXB-2096		96	2240	960	60	2570	2570	60
FXB-2103		103	2410	1020	60	2740	2740	60
FXB-2115		115	2690	1150	80	3060	3060	80
FXB-2125		125	2920	1250	80	3290	3290	80
FXB-2133		133	3110	1320	80	3480	3480	80
FXB-2138		138	3230	1370	80	3600	3600	80

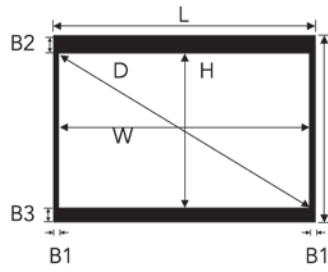

Vista Series Electric Fixed Frame Screen

Meki EFF screen is a high end fixed position screen with metal composite frame. It comes with two layers of screen; the rear layer is used for 2D projection, while the front layer is for 3D projection. The electric frame cleverly merges the two layers together, when not in use, the front screen is able to display a beautiful landscape image which looks like a painted drawing. The Electric Fixed Frame Screen provides a variety of wood surface frames. It is equipped with a high-grade, fashionable RF remote control.



STEP1
(Closed)



STEP2
(Open Half)



STEP3
(Full Open)

Suggest Materials Match:
Option A: Front Material-one Picture
Back Material-PVC White/Black

Option B: Front Material-PVC Grey/Black
Back Material-3D silver Film

Model	Ratio	Diagonal (inch)	Viewing Size W x H (mm)		Frame Width (mm)	Product Size L x A x B (mm)		
		D	W	H	B	L	A	B
EFXB-9100	4:3	100	2030	1520	160	2350	1840	125
EFXB-9120		120	2440	1830		2760	2150	
EFXB-9150		150	3050	2290		3370	2610	
EFXB-9180		180	3660	2740		3980	3060	
EFXB-9200		200	4060	3050		4380	3370	
EFXB-9100HB	16:9	100	2210	1240	160	2530	1560	125
EFXB-9106HB		106	2340	1320		2660	1640	
EFXB-9120HB		120	2650	1490		2970	1810	
EFXB-9150HB		150	3320	1870		3640	2190	
EFXB-9180HB		180	3980	2240		4300	2560	
EFXB-9200HB		200	4420	2500		4740	2820	

Control System

Wall switch Remote
RC01

Optional Frame Color:

W2302 W2001
W2202 W2201

Velvet Sticker Surface:

Frame Profile:

Operating Diagram:

Installation Diagram:

Vista Series Curved Fixed Frame Screen

Meki Curved Fixed Frame Screen is designed to reflect ultra wide projection images, ideally to project life sized objects or sceneries with two projectors or even more. The screen is wrapped with steel branches, borders are adjustable with sliding slot, which makes the screen level to be freely adjustable. It is easy to find the ideal position with the sliding type of mountings. Furthermore CFF screen are easy to assemble thus the installation process is fast.

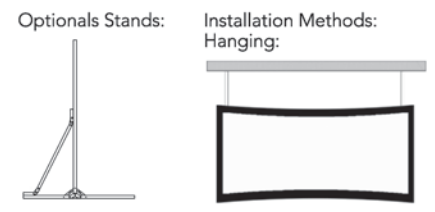
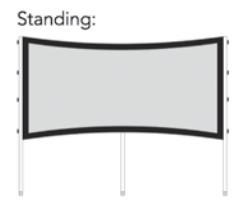

Model	Ratio	Diagonal (inch)	Viewing Size W x H (mm)		Four Black Border (mm)	Tube Diameter (mm)	Product Size (mm)		
		D	W	H	B2	B3	Width	Height	Deep
LCF-6072	4:3	72	1460	1100	50	100	1760	1200	225
LCF-6084		84	1710	1280			2010	1380	
LCF-6100		100	2030	1520			2330	1620	
LCF-6120		120	2440	1830			2740	1930	
LCF-6135		135	2740	2060			3040	2160	
LCF-6150		150	3050	2290			3350	2390	
LCF-6180		180	3660	2740			3960	2840	
LCF-6200	200	3940	2930	4240	3030				
LCF-9100HD	16:9	100	2210	1250	50	100	2510	1350	225
LCF-9120HD		120	2660	1490			2960	1590	
LCF-9150HD		150	3320	1870			3620	1970	
LCF-9180HD		180	3980	2240			4280	2340	
LCF-9200HD		200	4420	2940			4720	3040	

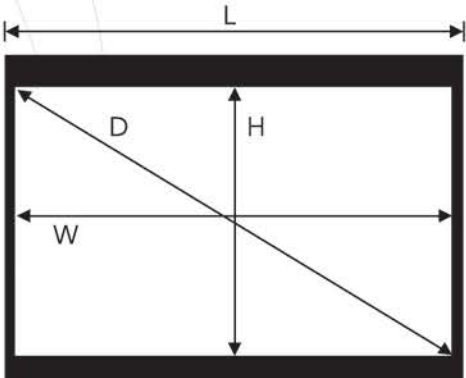

Vista Series Quick Fold Screen

- Optional front and rear projection
- Available up to 300" diagonal
- Foldable aluminium case
- Comes portable in hard plastic case with wheels
- Suitable for large or out door events
- Optional accessories: skirting or side laces
- Business Office & Education Projection Screen

Model	Ratio	Diagonal (inch)	Viewing Size W x H (mm)		Four Black Bordes (mm)	Frame Width (mm)	Casing Size L x A x B (mm)		
		D	W	H			L	A	B
LF-72V	4:3	72	1460	1100	50	36	1560	1200	97
LF-84V		84	1730	1220			1830	1320	
LF-100V		100	2030	1520			2130	1620	
LF-120V		120	2440	1830			2612	1930	
LF-150V		150	3050	2290			3222	2390	
LF-180V		180	3660	2740			3832	2840	
LF-200V		200	4060	3050			4232	3150	
LF-300V		300	6100	4570			6272	4670	

Vista Series Floor Screen

- Lightweight and easy installation system
- Available from 60" to 80" diagonal
- Durable hard metal casing
- Scissors joints that makes it strong and sturdy
- Portable and easy storage design

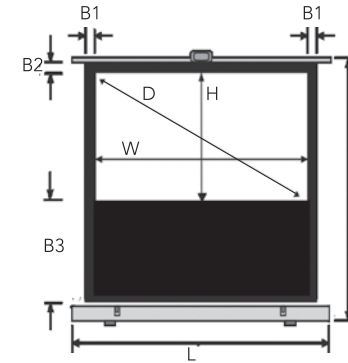

Model	Ratio	Diagonal (inch)	Viewing Size W x H (mm)		Left & Right Black Border (mm)	Top Black Border (mm)	Bottom Black Border (mm)	Casing Size L x A x B (mm)		
		D	W	H	B1	B2	B3	L	A	B
FS-POST-60D	4:3	60	1220	920	40	40	1050	1350	120	110
FS-POST-72D		72	1460	1090						
FS-POST-80D		80	1625	1220						
FS-POST-100D		100	2030	1520						

Vista Series Table Screen

- Lightweight and easy installation system
- Strong and durable foot stand
- Build with handle
- Available from 20" to 50" diagonal
- Suitable for travelling and small group presentation

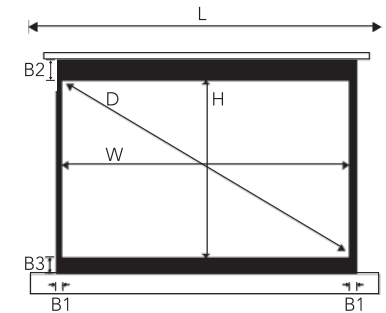

Model	Ratio	Diagonal (inch)	Viewing Size W x H (mm)		Top Black Border (mm)	Bottom Black Border (mm)	Casing Size L x A x B (mm)		
		D	W	H	B2	B3	L	A	B
TS01_20VM	4:3	20	410	300	25	25	510	410	70
TS01_30VM		30	610	460					
TS01_40VM		40	810	610					
TS01_50VM		50	1020	760					

Projector & Notebook Trolley

LPT-01



- Platform is height adjustable
- Power coated tube, its surface is processed by pickling, phosphating and static spraying
- 18mm fireproof board
- 4 Castor wheels, two of which have brakes

Model	Product Size (mm)	Packing	Packing Size (mm)	Gross Weight (kg)
LPT-01	900*420*360	1pcs/carton	51*44*13	8

LPT-02



- Two different platforms, provide more space for projector or notebook etc.
- Powder coated tube, its surface is processed by pickling, phosphating and static spraying
- 18mm fireproof board
- 4 Castor wheels, two of which have brakes

Model	Product Size (mm)	Packing	Packing Size (mm)	Gross Weight (kg)
LPT-02	780*520*480	1pcs/carton	70*48*9	12

LPT-03



- Table height adjusts instantly from 80-120cm
- Laptop shelf adjusts to convenient position required
- Unit folds up to be used as a dolly-trolley for ease to transport projection
- Comes with air cylinder lift system
- 2 Castor wheels, easy to move

Model	Product Size (mm)	Packing	Packing Size (mm)	Gross Weight (kg)
LPT-03	(880-1240)*500*400	1pcs/carton	92*43*13	12.5

LPT-04



- Platform is height adjustable
- Powder coated tube, its surface is processed by pickling, phosphating and static spraying
- 18mm fireproof board
- 4 Castor wheels, two of which have brakes

Model	Product Size (mm)	Packing	Packing Size (mm)	Gross Weight (kg)
LPT-04	1250*500*400	1pcs/carton	65*54*15	11

LPT-05



- Two platform design, top board with anti-drop protector
- Power coated tube, its surface is processed by pickling, phosphating and static spraying
- 18mm fireproof board
- 4 Castor wheels, two of which have brakes

Model	Product Size (mm)	Packing	Packing Size (mm)	Gross Weight (kg)
LPT-05	1200*600*450	1pcs/carton	120*61*10	18

LPT-06



- Two platform design, both of which are height adjustable
- Power coated tube, its surface is processed by pickling, phosphating and static spraying
- 4 Castor wheels, two of which have brakes

Model	Product Size (mm)	Packing	Packing Size (mm)	Gross Weight (kg)
LPT-06	1180*650*460	1pcs/carton	105*56*15	16.5

LPT-07

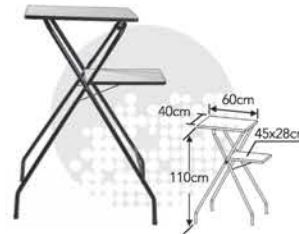

- Suits most projectors
- Power coated tube, its surface is processed by pickling, phosphating and static spraying
- 18mm fireproof board
- "X" structure, stronger and anti-swing

Model	Product Size (mm)	Packing	Packing Size (mm)	Gross Weight (kg)
LPT-07	1100*600*450	1pcs/carton	132*55*13	9

LPT-08



- Aluminum material & Industrial plastic
- 12mm cold rolled steel
- Easy to install & carry
- Max loading weight 10kg
- Height can be adjusted from 900-1200mm

Model	Product Size (mm)	Packing	Packing Size (mm)	Gross Weight (kg)
LPT-08	390*290*15	1pcs/carton	530*210*350	3

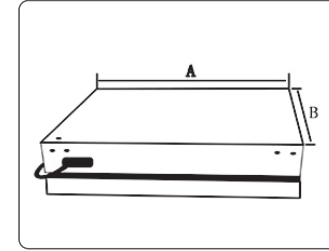
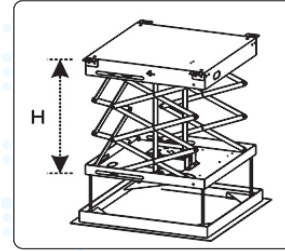
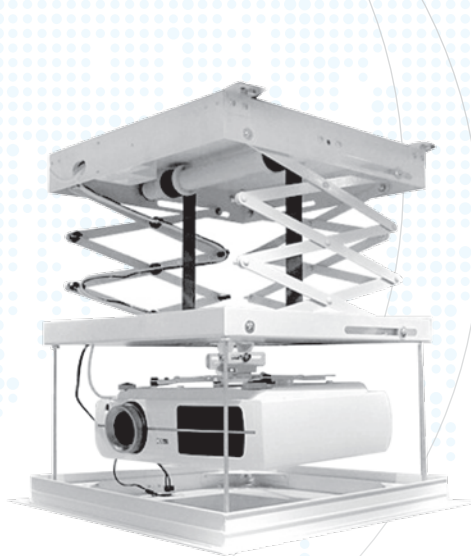

Projector Lift

- Integrating storage, demonstration and maintenance of scissors electric projector life
- The projector can be suspended or hide in the ceiling
- Accurately go down to the desired height for demonstration while using
- Classic scissors design is to make PL1 quiet and smooth when running
- A variety of height and weight to meet the needs of different environment
- Equip with wireless remote control at any corner of the room you can control it

Model	Product Size (mm)	Motor (W)	Max Loading (kg)	Extend Length (mm)	Platform Size (mm)
Mini-110 Mini-115 Mini-120	350*370*190 350*370*200 350*370*200	15	15	1000 1500 2000	500*500
BB-210 BB-215 BB-220 BB-230	400*410*250	25	25	1000 1500 2200 3000	500*500
BB-515 BB-525 BB-530 BB-550	525*435*720	40	40	1500 2500 3000 5000	500*500

Universal Screen Bracket

L1

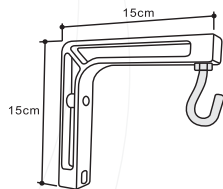

"L" Screen Bracket
15cm

L2

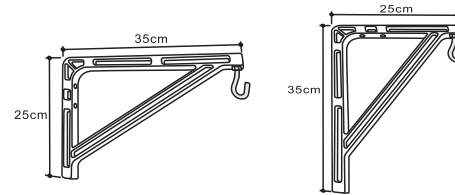

"L" Screen Bracket
35 or 25cm

L3

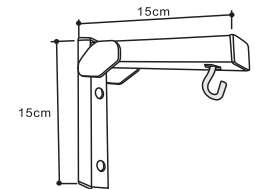
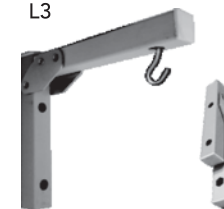

Foldable Screen
Bracket

LC & PM Series Projector Mount

LCS

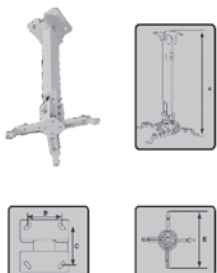

Feature & Specification:

- Material: Aluminium and magnesium alloys
- Color: White
- Selects the high quality cold rolled steel sheet, Aviation aluminium solid and reliable
- Super compatible with various adjustable angle, it is suitable to most of projector
- Wires through pipe, beauty and generous
- Pickling phosphating on the surface, electrostatic powder coating processing
- Plastic lining for inside and outside pipe to avoid damage

Model	Size (mm)				Max Loading (kg)
	A	B	C	E	
LCS-650	430-650	75	90	90-360	8
LCS-120	600-1200				
LCS-180	900-1800				

LCZ

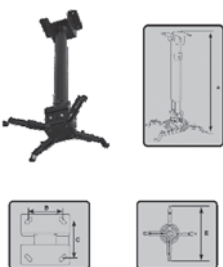

Feature & Specification:

- Material: Steel
- Color: Black
- Selects the high quality cold rolled steel sheet, Aviation aluminium solid and reliable
- Super compatible with various adjustable angle, it is suitable to most of projector
- Wires through pipe, beauty and generous
- Pickling phosphating on the surface, electrostatic powder coating processing
- Plastic lining for inside and outside pipe to avoid damage

Model	Size (mm)				Max Loading (kg)
	A	B	C	E	
LCZ-100	500-100	75	90	90-360	8
LCZ-200	1000-2000				

LCR

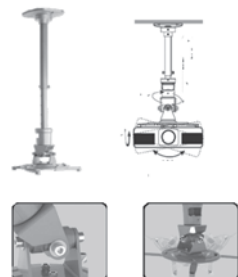

Feature & Specification:

- Material: Steel
- Color: Black
- Selects the high quality cold rolled steel sheet, Aviation aluminium solid and reliable
- Super compatible with various adjustable angle, it is suitable to most of projector
- Wires through pipe, beauty and generous
- Pickling phosphating on the surface, electrostatic powder coating processing

Model	Shape	Size (mm)	Max Loading (kg)
LCR	ceiling-type	10	8

PM-06

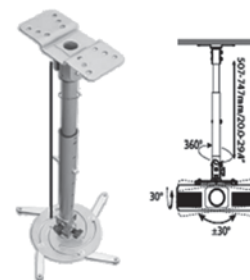

Feature & Specification:

- Material: Cold rolled silver
- Color: Silver
- Back leaning angle: $\pm 30^\circ$
- Turning: 360°
- Install way: Ceiling suspended

Model	Size (mm)	Packing Size (mm)	Weight (kg)	
			N.W	Bear Load
PM06	507-747	700 x 250 x 200	2	10

PM-07



Feature & Specification:

- Material: Cold rolled silver
- Color: Silver
- Back leaning angle: $\pm 15^\circ$
- Turning: 360°
- Install way: Ceiling suspended

Model	Size (mm)	Packing Size (mm)	Weight (kg)	
			N.W	Bear Load
PM07-100	140	560 x 203 x 285	2	15
PM07-600	420-640	560 x 390 x 285	3	15

PM-08



Feature & Specification:

- Material: Aluminium alloy
- Color: Black
- Back leaning angle: $\pm 30^\circ$
- Turning: 360°
- Distance from wall: 240-310mm
- Install way: Ceiling suspended

Model	Size (mm)	Packing Size (mm)	Weight (kg)	
			N.W	Bear Load
PM08-100	135	560 x 230 x 285	4	10
PM08-300	240-310	780 x 230 x 285	7	10
PM08-700	470-710	1090 x 230 x 285	9	15

ST Series Short Throw Projector Mount

ST-01

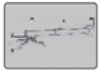

Feature & Specification:

- Material cold-roll steel sheets
- Color: white
- Selects the high quality cold rolled steel sheet, solid and reliable
- Super compatible with various adjustable angle, it is suitable to most the projector
- Wires through pipe, beauty and generous
- Pickling phosphating on the surface, electrostatic powder coating processing
- Plastic lining for inside and outside pipe

Model	Size (mm)					Packing Size (mm)	Weight (kg)		
	A	B	C	D	E		Gross Weight	Net Weight	Max Loading
ST01-60	370-610					520 x 250 x 220	6.1	2.7	
ST01-90	530-870					685 x 250 x 220	7.6	3.4	10
ST01-120	690-1200	120	170	90-360	65	830 x 250 x 220	8.7	3.9	
ST01-150	1030-1500					1170 x 250 x 220	10.4	4.7	

ST-03



Feature & Specification:

- Material: cold-rolled steel sheets
- Color: White
- Selects the high quality cold rolled steel sheet, solid and reliable
- Super compatible with various adjustable angle, it is suitable to most the projector
- Wires through pipe, beauty and generous
- Pickling phosphating on the surface, electrostatic powder coating processing
- Plastic lining for inside and outside pipe

Model	Size (mm)					Packing Size (mm)	Weight (kg)		
	A	B	C	D	E		Gross Weight	Net Weight	Max Loading
ST03-60	370-610					480 x 135 x 155	3.9	1.8	
ST03-90	530-870					640 x 135 x 155	5.2	2.4	10
ST03-120	690-1200	80	100	90-400	65	800 x 135 x 155	6.1	2.9	
ST03-150	1030-1500					1140 x 135 x 155	7.5	3.5	

ST-05



Feature & Specification:

- Material: Aluminium and magnesium alloys
- Color: Silver grey
- Selects the high quality cold rolled steel sheet, Aviation aluminium solid and reliable
- Super compatible with various adjustable angle, it is suitable to most of projector
- Wires through pipe, beauty and generous
- Pickling phosphating on the surface, electrostatic powder coating processing
- Plastic lining for inside and outside pipe to avoid damage

Model	Size (mm)					Packing Size (mm)	Weight (kg)		
	A	B	C	D	E		Gross Weight	Net Weight	Max Loading
ST05-60	150-600					760 x 250 x 220	3.2	5.9	25
ST05-90	150-900					1070 x 250 x 220	3.8	7.3	30
ST05-120	150-1200	120	170	90-360	120	1400 x 250 x 220	4.3	8.5	35
ST05-150	150-1500					1680 x 250 x 220	5	9.7	39

ST06



Feature & Specification:

- Material: Aluminium alloy
- Color: Silver
- Distance from wall: 685-1200mm
- Angle of inclination: $\pm 15^\circ$
- Turning: 360°
- Install way: Wall mounted

Model	Size (mm)	Packing Size (mm)	Weight (kg)	
			N.W	Bear Load
ST06-60	385-600	520 x 225 x 195	3	10
ST06-120	685-1200	820 x 225 x 195	7	15
ST06-160	885-1600	1220 x 225 x 195	8	15

ST07

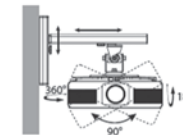

Feature & Specification:

- Material: Aluminium alloy
- Color: Silver
- Distance from wall: 685-1200mm
- Back leaning angle: 180°
- Turning: 360°
- Install way: Wall mounted

Model	Size (mm)	Packing Size (mm)	Weight (kg)	
			N.W	Bear Load
ST07	375	560 x 395 x 285	3	15

ST08

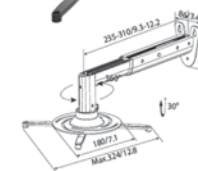

Feature & Specification:

- Material: Aluminium alloy
- Color: Silver
- Distance from wall: 410-632mm
- Angle of inclination: $\pm 30^\circ$
- Back leaning angle: 180°
- Turning: 360°
- Product weight: 7kg
- Install way: Wall mounted

Model	Size (mm)	Packing Size (mm)	Weight (kg)	
			N.W	Bear Load
ST08-30	235-310	500 x 475 x 250	3	10
ST08-60	410-632	600 x 475 x 250	3	10

HDMI Cables

GH-Z Series



GH-T Series



Specifications:

- Bandwidth up to 18gbps
- 4k@50/60(2160p), which is 4 times the clarity of 1080p/60 video resolution
- Up to 32 audio channels for a multi-dimensional immersive audio experience
- Up to 1536khz audio sample frequency for the highest audio fidelity
- Simultaneous delivery of dual video streams to multiple users on the same screen
- CEC extensions provide expanded command and control of electronics devices through a single control point
- Simultaneous delivery of multi-stream audio to multiple users(up to 4)
- Support for the wide angle theatrical 21:9 video aspect ratio
- Dynamic synchronization of video and audio streams

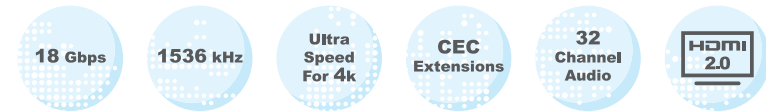

Model	Length	AWG	OD (mm)	Ultra HD	Audio
GH-Z-2	2.0m	30	7.3	4k x 2k @ 50160Hz	32 Channel
GH-Z-3	3.0m	30	7.3		
GH-Z-5	5.0m	28	7.3		
GH-Z-10	10.0m	26	8.0		
GH-Z-12	12.0m	26	8.0		
GH-Z-15	15.0m	24	9.0		

Specifications:

- High speed HDMI cable with Ethernet
- Up to 4k resolution
- EMI shielding
- 24k carat gold plated connectors
- High quality aluminium shell
- Protective nylon cable covering the whole cable
- Bandwidth: 18gbps
- HDMI certified
- Flat belt cable for better cable management

Model	Length	AWG	OD (mm)	Ultra HD	Audio
GH-T-2	2.0m	30	7.3	4k x 2k @ 50160Hz	32 Channel
GH-T-3	3.0m				
GH-T-5	5.0m				

Screen Fabrics

Parameter Specification

Model	Description	Gain	View Angle	Thickness	Tensioned/ Non-Tensioned	Front/Rear Projection	Cleanable
VS-P8001	Eco-Matte White	1.1	100°	0.38±0.02(mm)	Non-Tensioned	Front	Yes
VS-P8002	Mid-Matte White	1.1	100°	0.42±0.02(mm)	Non-Tensioned	Front	Yes
VS-P8003	Pro-Matte White	1.1	100°	0.45±0.02(mm)	Non-Tensioned	Front	Yes
VS-P8004	S-Pro-Matte White	1.1	100°	0.55±0.02(mm)	Non-Tensioned	Front	Yes
VS-P8005	Matte Grey	1.0	90°	0.45±0.02(mm)	Non-Tensioned	Front	Yes
VS-P8006	Fiber Glass	1.1	100°	0.50±0.02(mm)	Non-Tensioned	Front	Yes
VS-P8007	Glass Beaded	2.1	100°	0.47±0.02(mm)	Non-Tensioned	Front	No
VS-P8008	PVC White- Black	1.1	100°	0.32±0.02(mm)	Tensioned	Front	Yes
VS-P8009	PVC Grey-Black	1.0	90°	0.32±0.02(mm)	Tensioned	Front	Yes
VS-P8010	PVC Grey Translucent	1.8	60°	0.32±0.02(mm)	Tensioned	Rear	Yes
VS-P8011	3D Silver Film	3.2	140°	0.35±0.02(mm)	Tensioned	Front	Yes
VS-P8012	PVC White-White	1.3	100°	0.35±0.02(mm)	Tensioned	Front	Yes
VS-P8013	PVC White-Black	1.3	100°	0.35±0.02(mm)	Tensioned	Front	Yes
VS-P8014	PVC White-Grey	1.3	100°	0.35±0.02(mm)	Tensioned	Front	Yes
VS-P8015	PVC Smoke Translucent	2.3	70°	0.32±0.02(mm)	Tensioned	Rear	Yes
VS-P8016	PVC White Translucent	2.3	70°	0.32±0.02(mm)	Tensioned	Rear	Yes
VS-P8017	PVC Black Translucent	2.3	70°	0.32±0.02(mm)	Tensioned	Rear	Yes
VS-P8018	3D Silver Film	3.5	160°	0.35±0.02(mm)	Tensioned	Front	Yes

*We able to customize all above ratios for any types of screen

Screen Ratio:



1:1

1:1 for smaller project sizes and higher rooms mainly



4:3

4:3 for video and PC image mainly, for demonstration and teaching

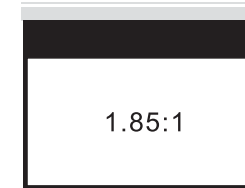

1.85:1

1:85:1 for television signal image of wide screen mainly

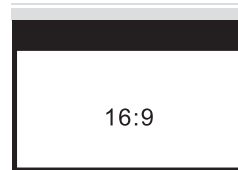

16:9

16:9 for High-definition television image mainly, for home theatre

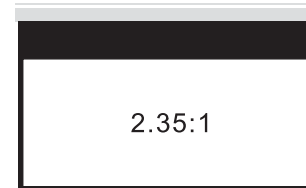

2.35:1

2:35:1 for stereo image of wide screen mainly

Other Related Products

